

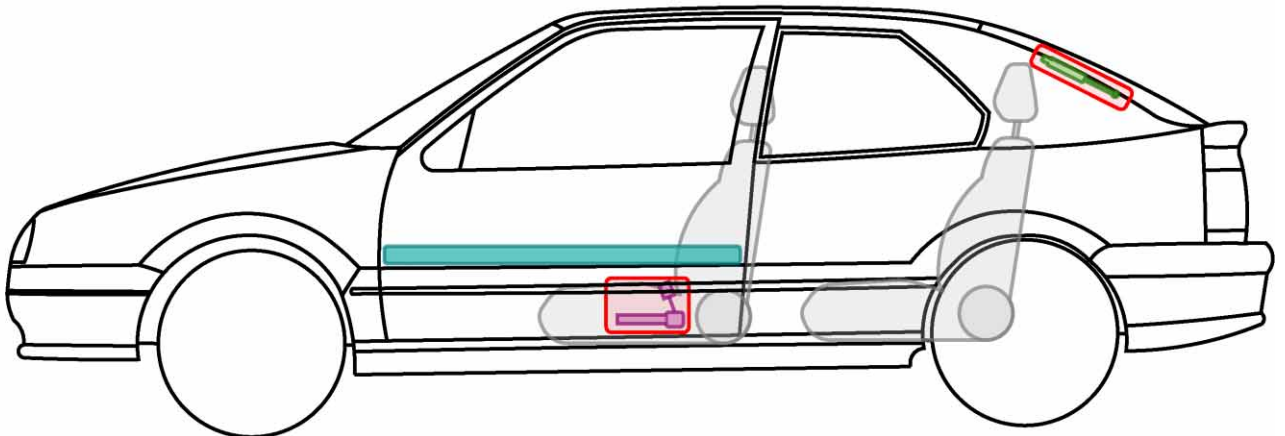

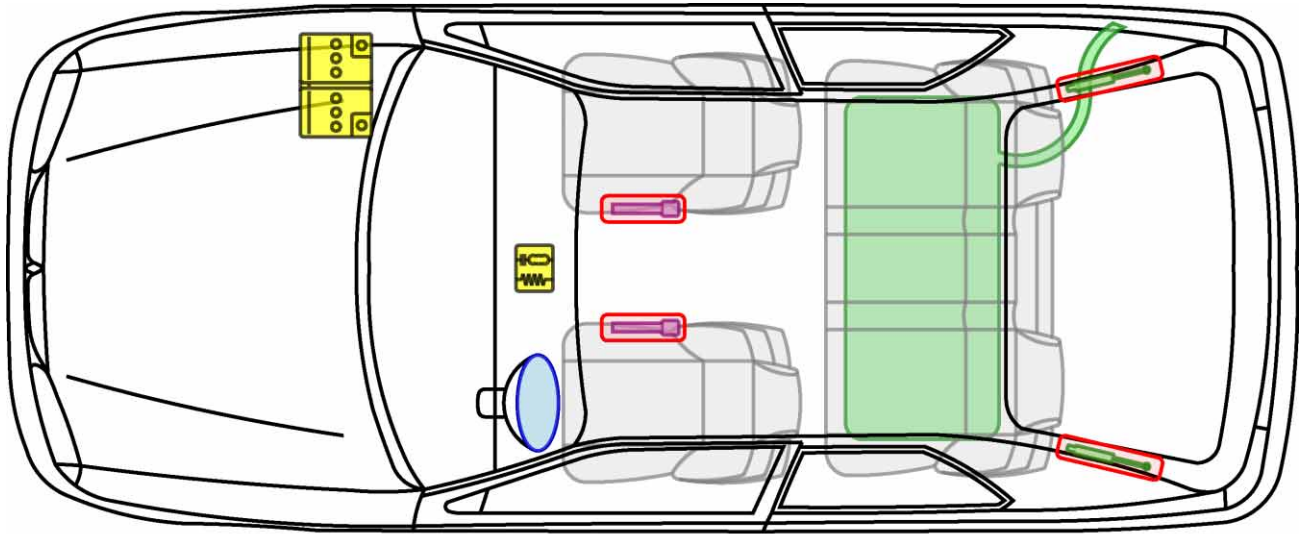









# R19 3-Türer

TYP: B/C53, X53, 1994-1995

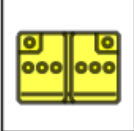

## Legende

	Airbag		Karosserie- verstärkung		Steuergerät
	Gas- generator		Überroll- schutz		Batterie
	Gurt- straffer		Gasdruck- dämpfer		Kraftstoff- tank







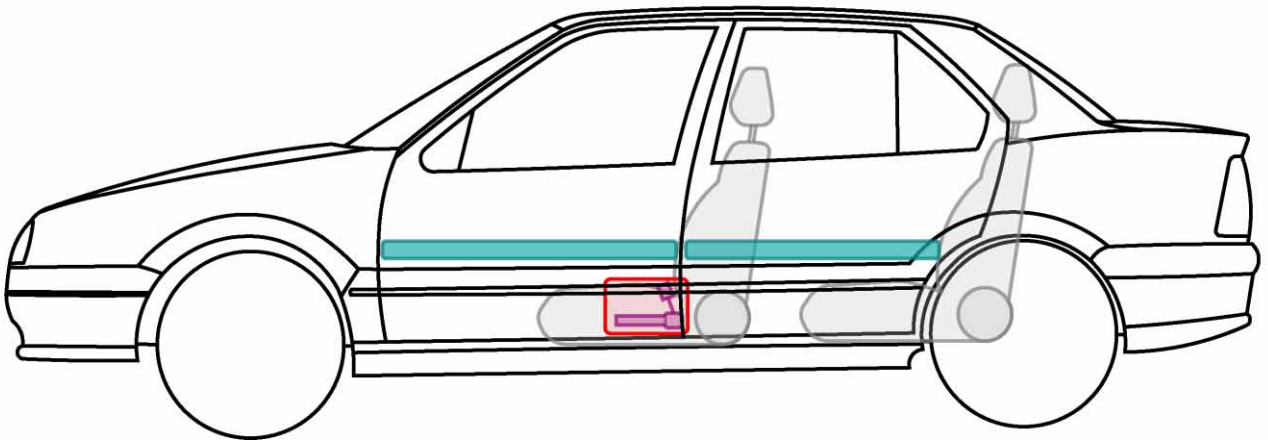
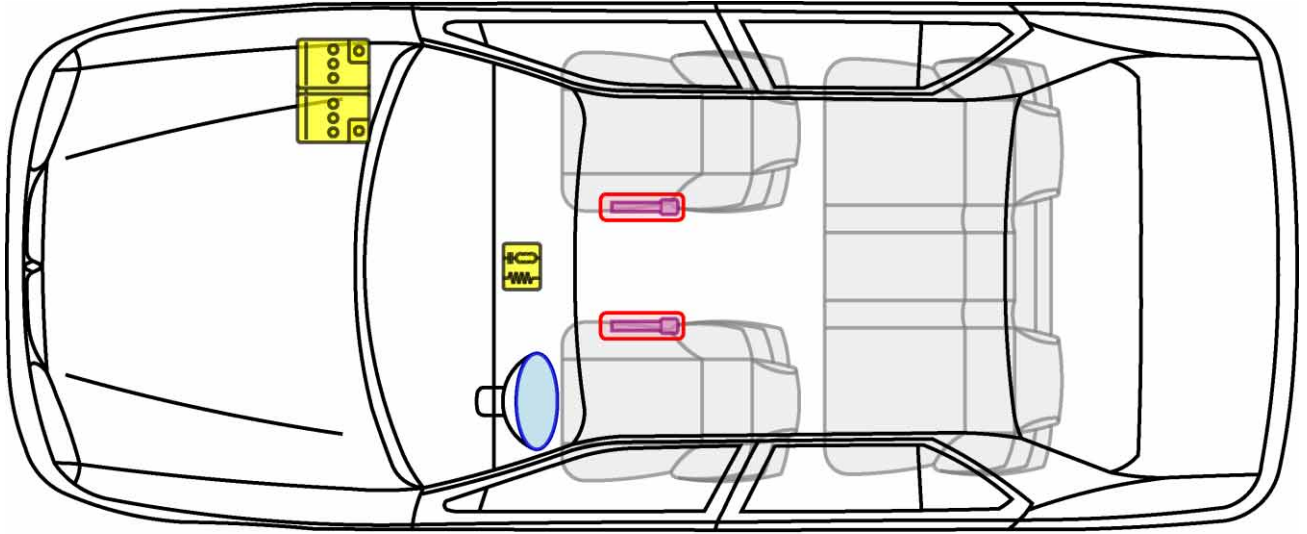



# R19 4-Türer

TYP: L53, X53, 1994-1995

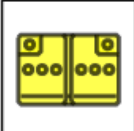

## Legende

	Airbag		Karosserie- verstärkung		Steuergerät
	Gas- generator		Überroll- schutz		Batterie
	Gurt- straffer		Gasdruck- dämpfer		Kraftstoff- tank







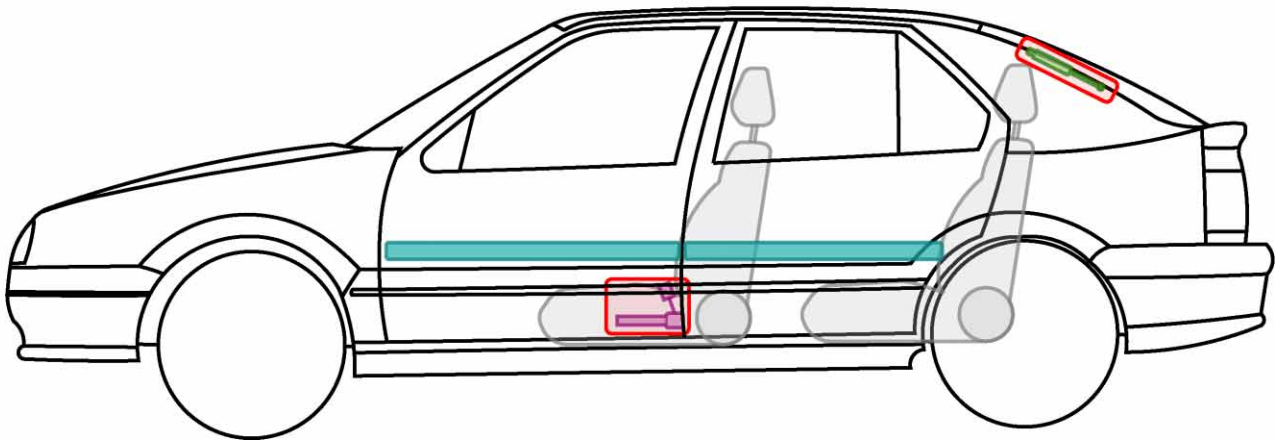
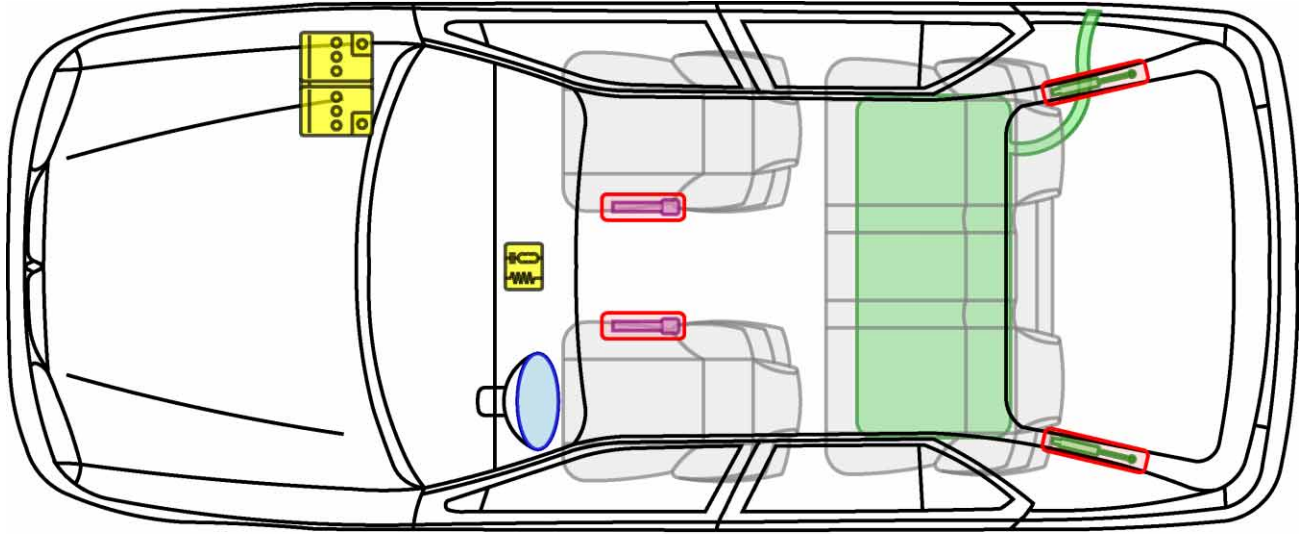



# R19 5-Türer

TYP: B53, X53, 1994-1996

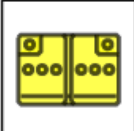

## Legende

	Airbag		Karosserie-verstärkung		Steuergerät
	Gas-generator		Überroll-schutz		Batterie
	Gurt-straffer		Gasdruck-dämpfer		Kraftstoff-tank



# R19 CABRIOLET

TYP: D53, 1995-1996

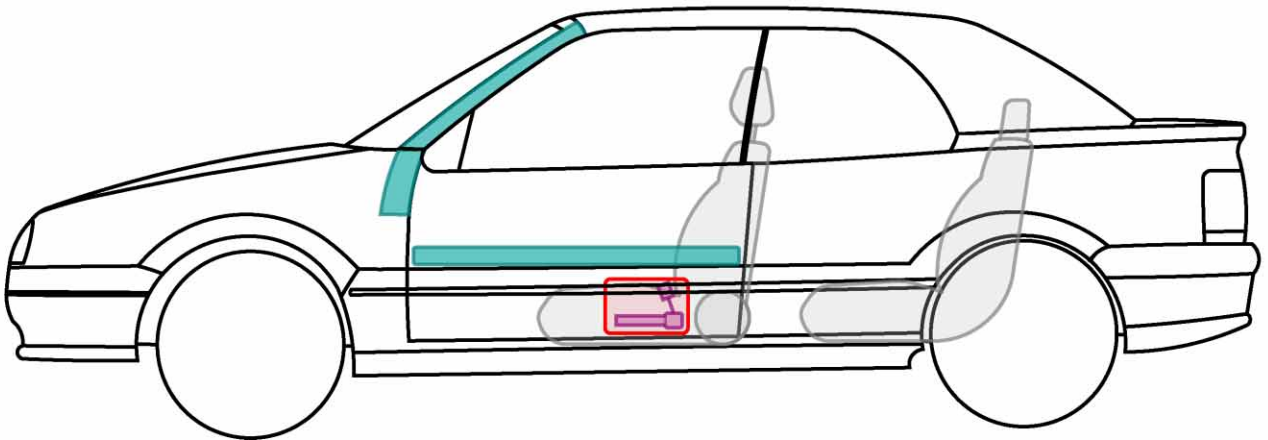
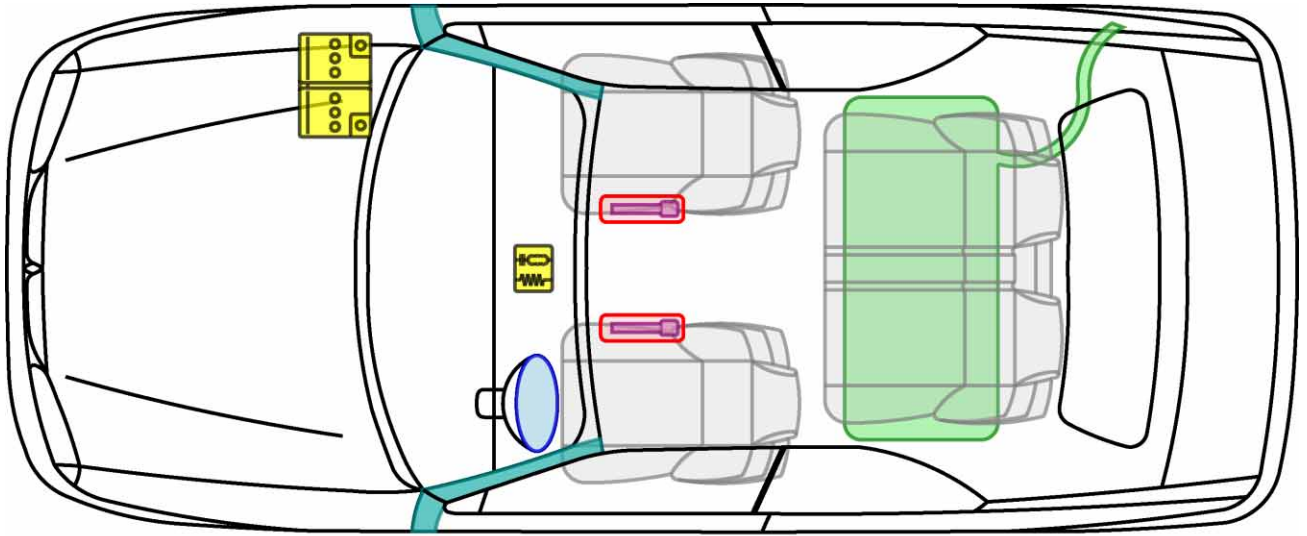

## Legende

	Airbag		Karosserie- verstärkung		Steuergerät
	Gas- generator		Überroll- schutz		Batterie
	Gurt- straffer		Gasdruck- dämpfer		Kraftstoff- tank